

Starhawk™ ASSEMBLY INSTRUCTIONS

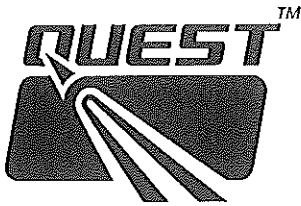

Prod. No. 1502

Skill Level One



Things You'll Need To Assemble this Kit:

Hobby Knife and Pencil



White Glue

Aliphatic Resin glues work best such as TITEBOND or ELMER'S CARPENTER'S WOOD GLUE - ELMER'S WHITE SCHOOL GLUE also works but dries slower.



BEFORE STARTING ASSEMBLY READ THROUGH THESE INSTRUCTIONS. IT IS BEST TO TEST FIT ALL PARTS BEFORE APPLYING ANY GLUE. READ AND FOLLOW THE NAR MODEL ROCKET SAFETY CODE.

PARTS LIST

- A. 49000 Motor Clip
- B. 10303S Yellow Motor Mount Tube
- C. 14000 Blue Thrust Ring
- D. 21550 Plastic Fin Unit
- E. 11202 10 inch White Body Tube
- F. 20075 Plastic Nose Cone
- G. 50014 21 inch White Elastic Shock Cord
- H. 50051 18 inch Kevlar* Shock Cord
- I. 28150 24 inch Plastic Streamer
- J. 28004 Single Gripper Tab
- K. 91501 Decal
- L. 96001R Instructions

* Kevlar is a registered trademark of Dupont

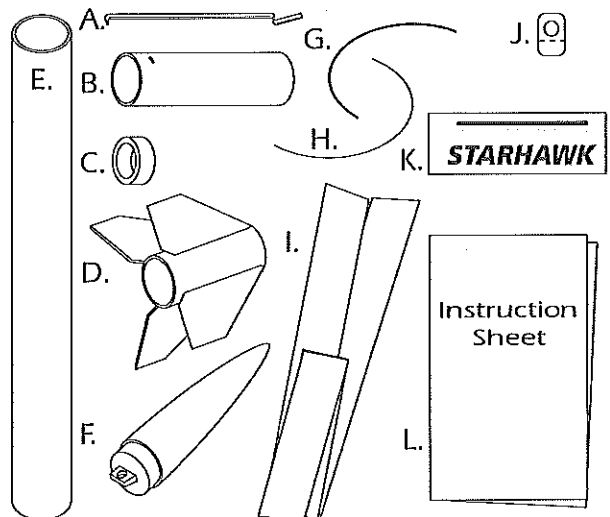

STEP 1

A. Hold the Yellow Kevlar Shock Cord and the White Elastic Shock Cord side by side. Pull one end of each cord so that they are even with each other. While holding the two cords together, tie a single parallel overhand knot approximately one inch in from the even ends as shown.

B. Gently pull on both cords to set the knot and prevent it from slipping.

C. Apply a small amount of white glue on the ends of both cords to prevent them from fraying.

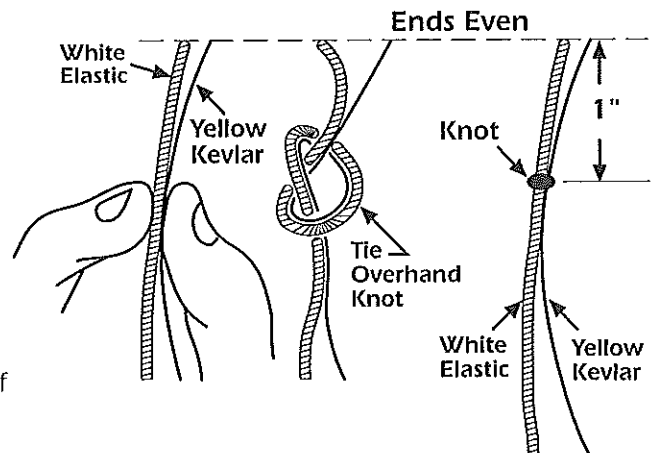

NOTE: THIS IS A VERY IMPORTANT STEP. IF YOU TIE A DIFFERENT TYPE OF KNOT THE SHOCK CORDS MAY SEPARATE DURING FLIGHT.

32908

STEP 2

A. Use a sharp hobby knife to cut a shallow "V" slot in the Blue Thrust Ring as shown. Test fit the Blue Thrust Ring into one end of the Yellow Motor Mount Tube. If the fit is tight, sand the outside of the Blue Thrust Ring until you get a looser fit.

B. Tie the Yellow Kevlar Shock Cord onto the Blue Thrust Ring using two overhand knots as shown. Be sure the shock cord lays in the "V" you made in the Blue Thrust Ring.

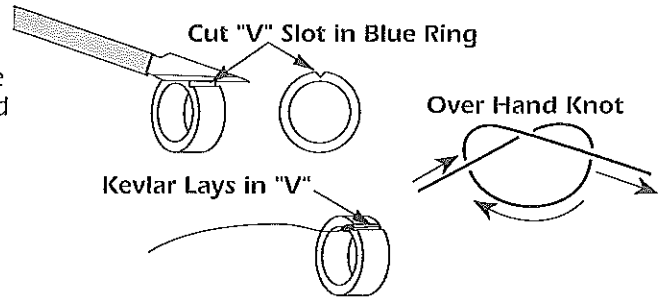

STEP 3

A. Apply white glue around the inside edge of the Yellow Motor Mount Tube in the end with a slit in it, as shown.

B. Insert the Blue Thrust Ring into the Yellow Motor Mount Tube with the Yellow Kevlar and knot facing as shown until it is even with the end of the Yellow Motor Mount Tube.

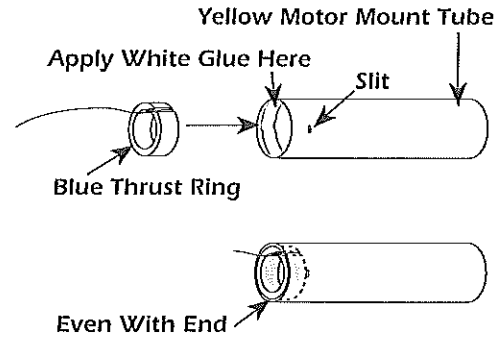

STEP 4

A. Using the ruler on the front of the instruction sheet, make a pencil mark 1/4 inch from the end of the Yellow Motor Mount Tube as shown.

B. "Feed" the shock cord back through the Yellow Motor Mount as shown.

C. Make a slight bend in the motor clip as shown. Insert the clip into the slit in the Yellow Motor Mount Tube.

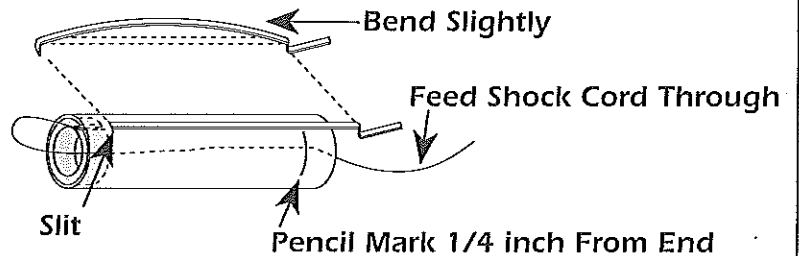

STEP 5

A. Apply white glue around the inside of one end of the White Body Tube.

B. Orient the Yellow Motor Mount tube as shown and immediately insert it into the White Body Tube and PUSH INTO THE BODY TUBE WITH ONE FAST & SMOOTH MOTION up to the 1/4 inch pencil mark on the Yellow Motor Mount Tube as shown.

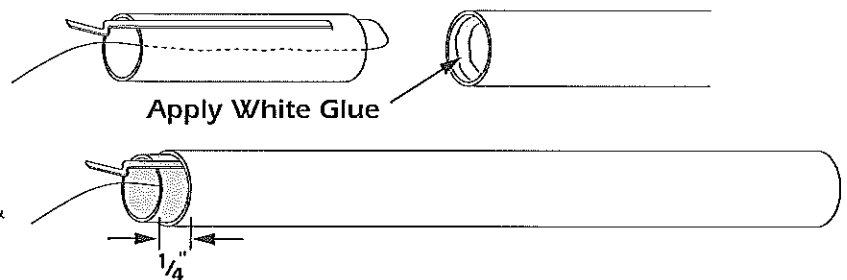

STEP 6

A. Feed the Shock Cord back through the body tube as shown.

B. Slide the One-Piece Molded Plastic Fin Unit onto the body tube as shown.

C. Slide the Fin Unit onto the body tube until it is flush with the end of the White Body Tube.

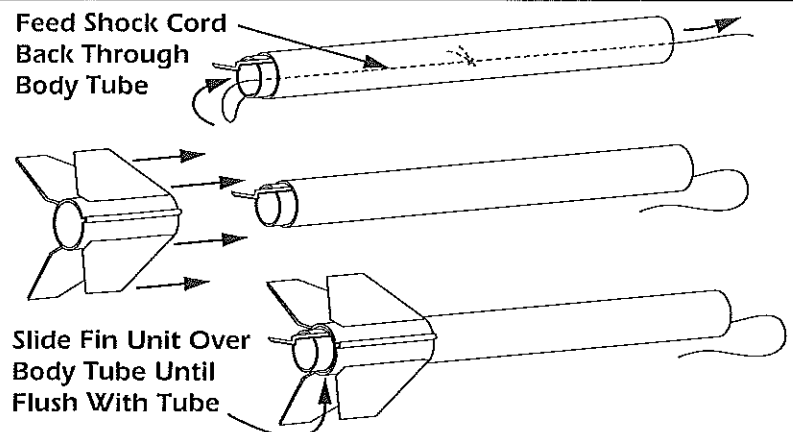

STEP 7

- A. Peel the backing off the gripper tab and attach it to one end of the plastic streamer. Firmly squeeze the gripper tab and streamer between your fingers.
- B. Feed the loose end of the shock cord through the hole in the gripper tab.
- C. Use two overhand knots to tie the loose end of the shock cord onto the nose cone.

Attach Gripper
To Streamer

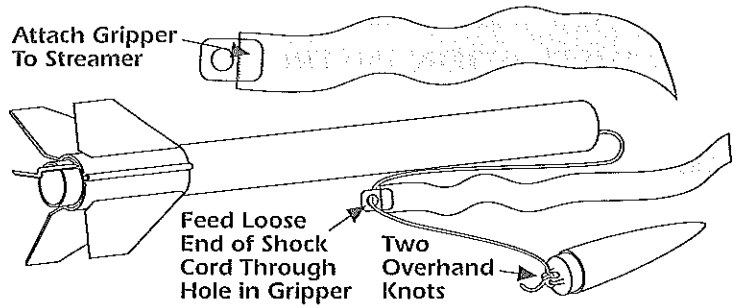

Feed Loose
End of Shock
Cord Through
Hole in Gripper

Two
Overhand
Knots

STEP 8

- A. Apply the self-adhesive decal to your rocket as shown here.

NOTE: Use caution when removing the decal from the backing to prevent decal from curling over onto itself.

OPTIONAL PAINT SCHEME: Paint the body tube semi-gloss black. Cut the white bands out of the decal with a sharp hobby knife and apply each fluorescent band separately to the body tube.

NOTE: For the best surface finish on your rocket, spray entire model with primer and sand before painting.

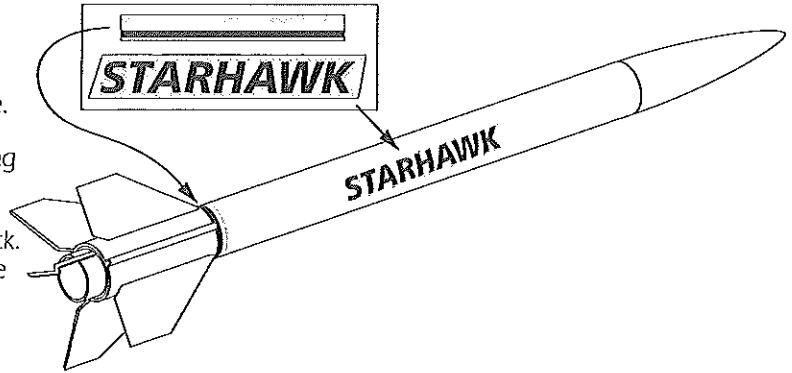

FLYING YOUR STARHAWK ROCKET

WHAT ELSE YOU WILL NEED:

To successfully fly your rocket you will need the following items:

- QUEST Launch Pad (No. 7610)
- QUEST Launch Controller (No. 7510)
- QUEST Parachute Recovery Wadding (No. 7020)
- QUEST Rocket Motors, Type A6-4, A8-3, B6-4

PREPPING YOUR ROCKET FOR FLIGHT

STEP 1

Pull the shock cord all the way out of the body tube. Crumple three sheets of recovery wadding and insert one by one into the body tube making sure that the knot between the Kevlar and white elastic shock cord is on the nose cone side of the wadding. Wadding should fit loosely in the tube but tight enough to form a good seal against the wall of the body tube.

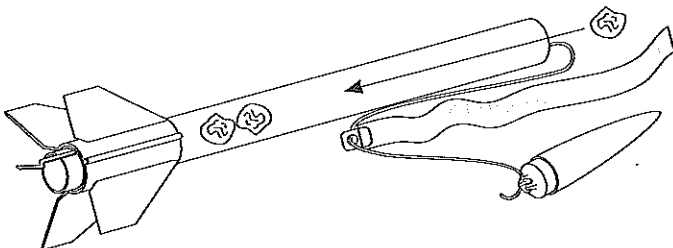

STEP 2

- A. Grab the plastic streamer at its center and fold it in half. Continue to fold the streamer in half until small enough to roll tightly.

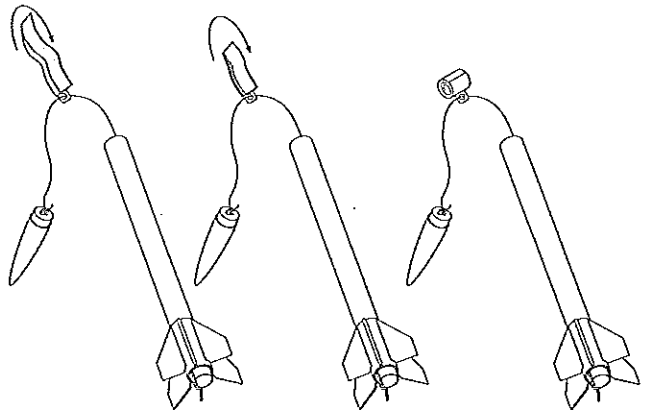

STEP 3

- A. Pack the streamer into the body tube THE STREAMER MUST SLIDE EASILY INTO THE BODY TUBE. If it is a tight fit, remove and re-fold and roll the streamer tighter.
- B. Push the shock cord into the body tube and re-fit the nose cone onto the rocket. BE CAREFUL NOT TO CATCH ANY OF THE SHOCK CORD BETWEEN THE SHOULDER OF THE NOSE CONE AND THE BODY TUBE.

READ AND FOLLOW THE LAUNCHING PROCEDURES

READ AND FOLLOW THE N.A.R. SAFETY CODE
DURING ALL YOUR MODEL ROCKETRY ACTIVITIES.